

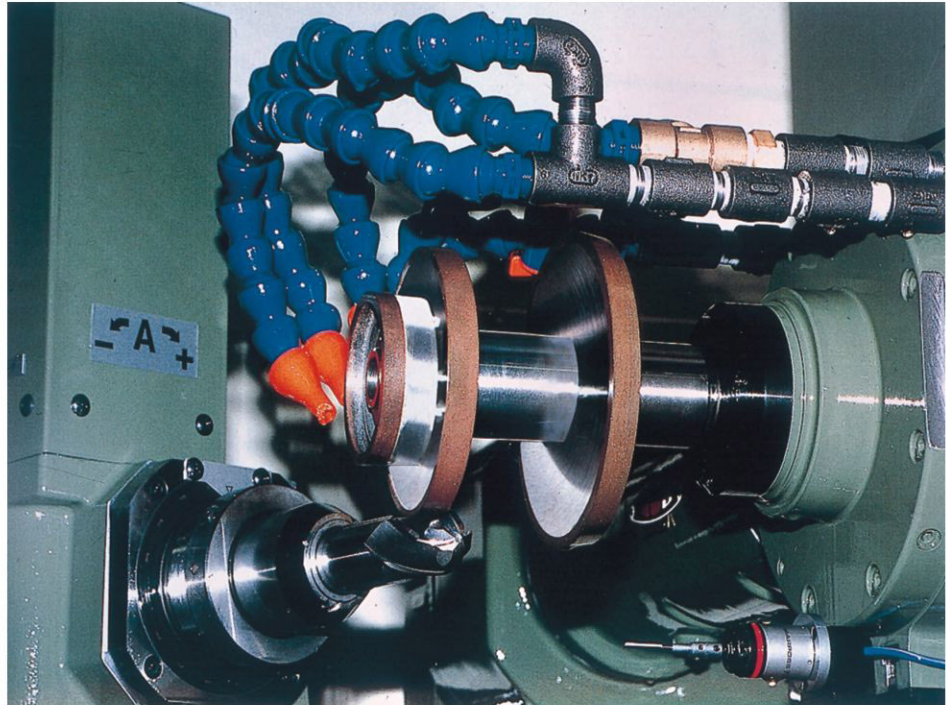

248, Hwakong St., Padeh City,
Taoyuan Hsien, Taiwan
Tel : 886-3-3636971
Fax : 886-3-3620709
http : //taiwandiamond.com
E-mail :
sales@taiwandiamond.com.tw

DEEP CREEP FEED GRINDING WHEELS



TAIWAN ASAHI DIAMOND INDUSTRIAL CO., LTD.

Usual Dimensions

1A1

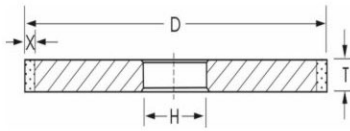

D (mm)	T (mm)	X (mm)	H (mm)
125	8 ~ 12	5, 6	On Request
150			

3A1 , 14A1

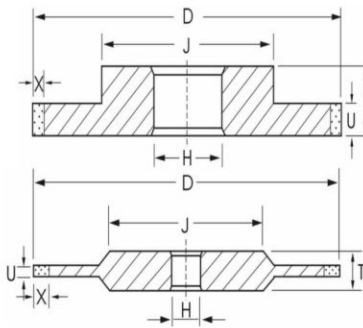

D (mm)	T (mm)	X (mm)	U (mm)	H (mm)
125	8 ~ 12	3, 5	1 ~ 3	On Request
150		5, 6	4 ~ 10	

1V1

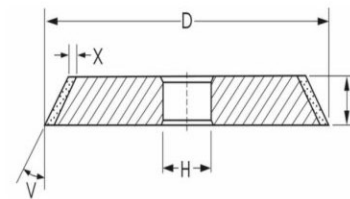

D (mm)	T (mm)	X (mm)	V°	H (mm)
125	8 ~ 12	5, 6	10° 15° 20° 30° 45°	On Request
150				

3V1 , 14V1

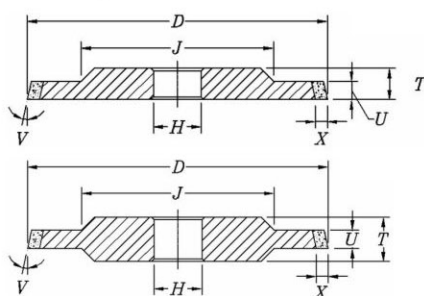

D (mm)	T (mm)	X (mm)	V°	U (mm)	H (mm)
125	8 ~ 12	3, 5	10° 15° 20° 30° 45°	1 ~ 3	On Request
150		5, 6	4 ~ 10		

11V9

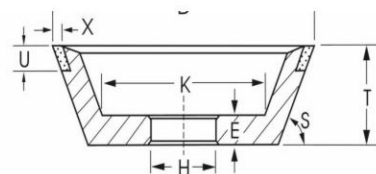

D (mm)	S	U (mm)	X (mm)	T (mm)	H (mm)
75	70°	6, 8, 10	3	30,35	On Request
85					
90					
100					
125					

12V9

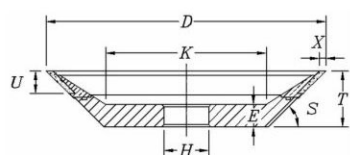

D (mm)	S	U (mm)	X (mm)	T (mm)	H (mm)
100	45°	6, 8, 10	3	25,30	On Request
110					
125					

NOTE : Other Dimensions On Request

